

Basic Characteristics Data

Model	Circuit method	Switching frequency [kHz]	Input current *1 [A]	Inrush current protection	PCB/Pattern			Series/Parallel operation availability *2	
					Material	Single sided	Double sided	Series operation	Parallel operation
LGA50A	Forward Converter	130	1.3	Thermistor	CEM-3	Yes		Yes	No
LGA75A	Forward Converter	130	1.7	Thermistor	CEM-3	Yes		Yes	No
LGA100A	Forward Converter	130	2.4	SCR	CEM-3	Yes		Yes	No
LGA150A	Forward Converter	130	3.6	SCR	CEM-3	Yes		Yes	No
LGA240A	Forward Converter	130	5.0	SCR	CEM-3	Yes		Yes	No

*1 The value of input current is at ACIN 100V and rated load.

*2 Refer to Instruction Manual 2.

LGA

1	Function	LGA-14
1.1	Input voltage range	LGA-14
1.2	Inrush current limiting	LGA-14
1.3	Overcurrent protection	LGA-14
1.4	Overvoltage protection	LGA-14
1.5	Output voltage adjustment range	LGA-14
1.6	Isolation	LGA-14
2	Series Operation and Parallel Operation	LGA-14
3	Assembling and Installation Method	LGA-15
3.1	Installation method	LGA-15
3.2	Derating	LGA-15
3.3	Mounting screw	LGA-18
3.4	Expectancy life and warranty	LGA-18
4	Ground	LGA-19
5	Option and Others	LGA-19
5.1	Outline of options	LGA-19
5.2	Others	LGA-20

1 Function

1.1 Input voltage range

LGA

- The range is from AC85V to AC132V.
- AC input voltage must have a range from AC85V to AC132V for normal operation. If the wrong input is applied, the unit will not operate properly and/or may be damaged.
- In cases that conform with safety standard, input voltage range is AC100-AC120V(50/60Hz).

1.2 Inrush current limiting

- Inrush current limiting is built-in.
- If a switch is being used for input, ensure that it is configured to handle the input inrush current.

● LGA50A, LGA75A

- If the unit is shut down, recycling AC line has to be done after cooling down the unit since thermistor is used for the protection from the inrush current.

● LGA100A, LGA150A, LGA240A

- The SCR is used for protection from inrush current. When power is turned ON/OFF repeatedly within a short period of time, it is necessary to have enough time between power ON and OFF to operate resistance circuit for inrush current.

1.3 Overcurrent protection

- Overcurrent protection is built-in and comes into effect at over 105%(-H is 101% or more of the peak current) of the rated current. Overcurrent protection prevents the unit from short circuit and overcurrent condition of less than 15 seconds. The unit automatically recovers when the fault condition is cleared.

● LGA50A-3R3-Y, LGA50A-5, LGA75A-3R3-Y, LGA75A-5, LGA100A-3R3-Y, LGA100A-5-Y, LGA150A-3R3-Y, LGA150A-5-Y

- Intermittent current characteristics.
- When the output voltage drops at overcurrent, the average output current is reduced by intermittent operation of power supply.

1.4 Overvoltage protection

- An overvoltage protection circuit is built-in. The AC input should be shut down if overvoltage protection is in operation. The minimum interval of AC recycling for recovery is 1.5 minutes (LGA240A is 3minutes).

* The recovery time varies depending on input voltage.

Remarks:

Please avoid applying the over-rated voltage to the output terminal. Power supply may operate incorrectly or fail. In case of operating a motor etc., please install an external diode on the output terminal to protect the unit.

1.5 Output voltage adjustment range

- Adjustment of output voltage is possible by using potentiometer. Please refer to instruction manual 5.1.
- Option "-Y" is recommended which can adjust the output voltage.

1.6 Isolation

- For a receiving inspection, such as Hi-Pot test, gradually increase (decrease) the voltage for the start (shut down). Avoid using Hi-Pot tester with the timer because it may generate voltage a few times higher than the applied voltage, at ON/OFF of a timer.

2 Series Operation and Parallel Operation

- Series operation is available by connecting the outputs of two or more power supplies with the same output voltage, as shown below. Output current in series connection should be lower than the lowest rated current in each unit.

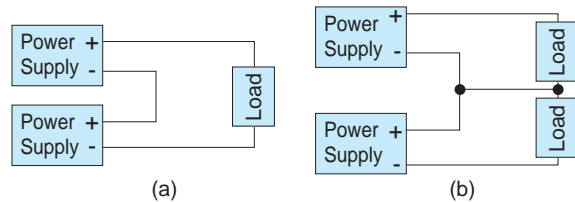

Fig.2.1 Examples of connecting in series operation

- Parallel operation is not possible.
- Redundancy operation is available by wiring as shown below.

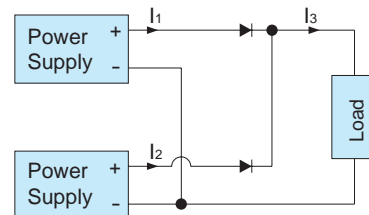

Fig.2.2 Example of redundancy operation

- Even a slight difference in output voltage can affect the balance between the values of I_1 and I_2 . Please make sure that the value of I_3 does not exceed the rated current of a power supply.

$$I_3 \leq \text{the rated current value}$$

3 Assembling and Installation Method

3.1 Installation method

- This power supply is manufactured by SMD technology. The stress to P.C.B like twisting or bending causes the defect of the unit, so handle the unit with care.
- In case of metal chassis, keep the distance between d_1 & d_2 for to insulate between lead of component and metal chassis, use the spacer of 8mm or more between d_1 . If it is less than d_1 & d_2 , insert the insulation sheet between power supply and metal chassis.

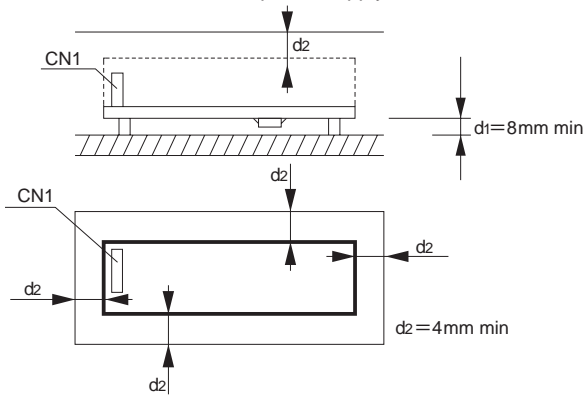
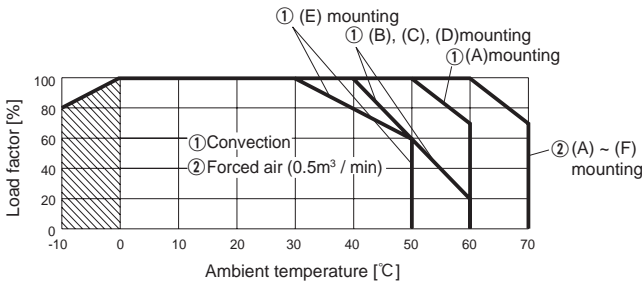

Fig.3.1 Installation method

3.2 Derating

- The operative ambient temperature is different by with / without chassis cover or mounting position. Please refer drawings as below. Note: In the hatched area, the specification of Ripple, Ripple Noise is different from other area.

● LGA50A-3R3-Y, -5, -12, -15



* [F] mounting should be operated by Forced air.
Fig.3.2 Ambient temperature derating curve

● LGA50A-3R3-Y, -5, -12, -15 -SN (with Chassis & Cover)

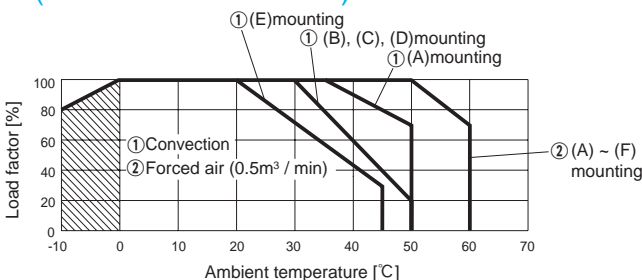

* [F] mounting should be operated by Forced air.
Fig.3.3 Ambient temperature derating curve

● LGA50A-24, -48

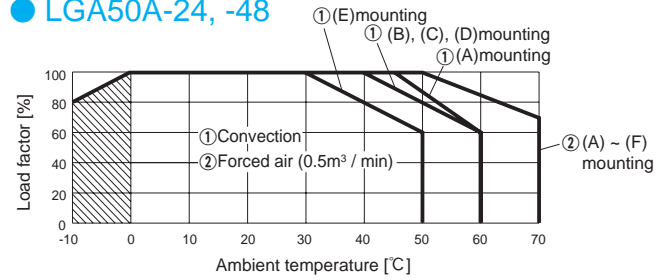

* [F] mounting should be operated by Forced air.
Fig.3.4 Ambient temperature derating curve

● LGA50A-24, -48 -SN (with Chassis & Cover)

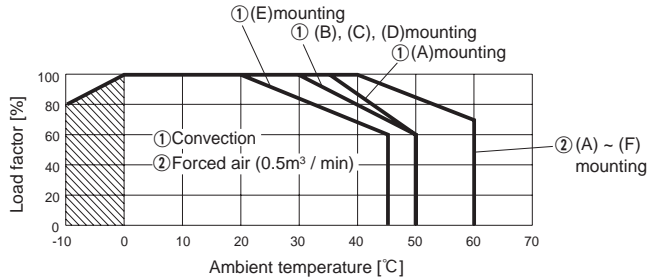

* [F] mounting should be operated by Forced air.
Fig.3.5 Ambient temperature derating curve

● LGA75A

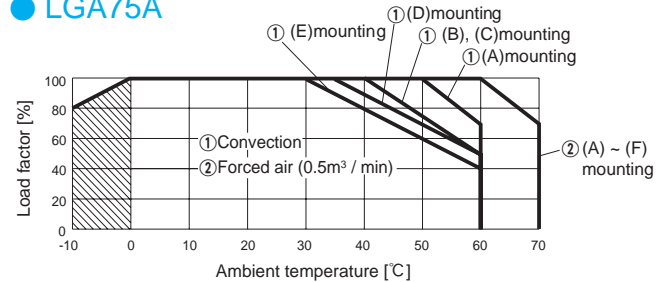

* [F] mounting should be operated by Forced air.
Fig.3.6 Ambient temperature derating curve

● LGA75A-□-SN (with Chassis & Cover)

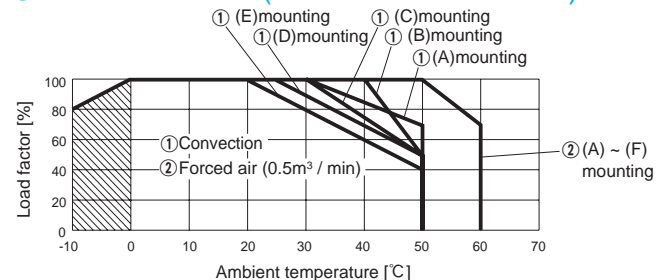

* [F] mounting should be operated by Forced air.
Fig.3.7 Ambient temperature derating curve

● LGA100A

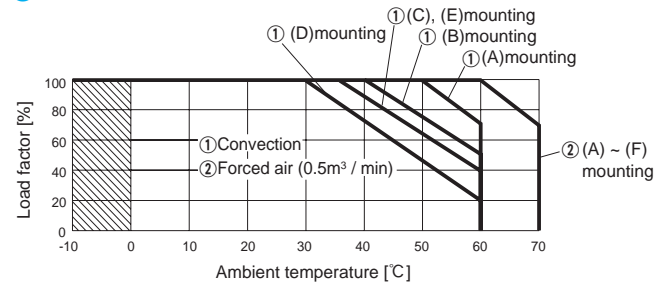

* [F] mounting should be operated by Forced air.
Fig.3.8 Ambient temperature derating curve

● LGA100A-□-SN (with Chassis & Cover)

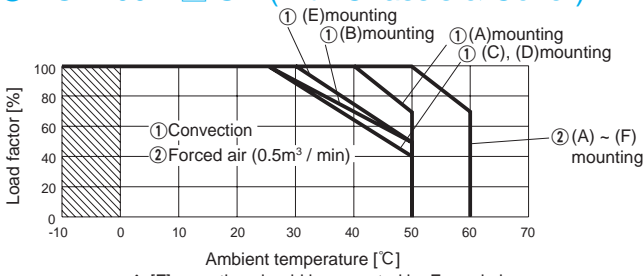

* [F] mounting should be operated by Forced air.
Fig.3.9 Ambient temperature derating curve

● LGA150A

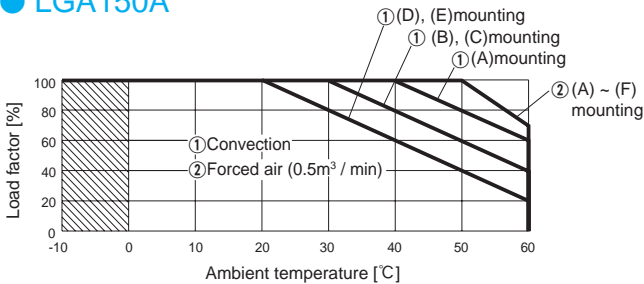

* [F] mounting should be operated by Forced air.
Fig.3.10 Ambient temperature derating curve

● LGA150A-□-SN (with Chassis & Cover)

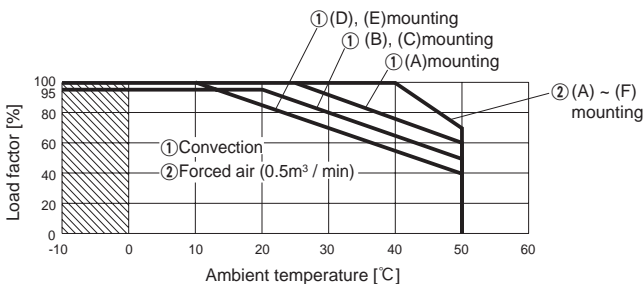

* [F] mounting should be operated by Forced air.
Fig.3.11 Ambient temperature derating curve

● LGA240A

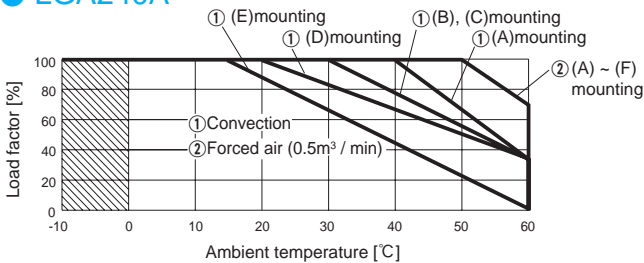

* [F] mounting should be operated by Forced air.
Fig.3.12 Ambient temperature derating curve

● LGA240A-□-SN (with Chassis & Cover)

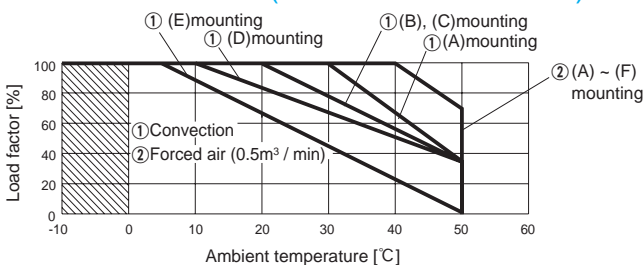

* [F] mounting should be operated by Forced air.
Fig.3.13 Ambient temperature derating curve

■ Derating curve depending on input voltage

Derating curve depending on input voltage is shown in Fig.3.14.

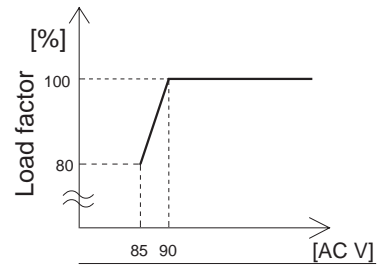
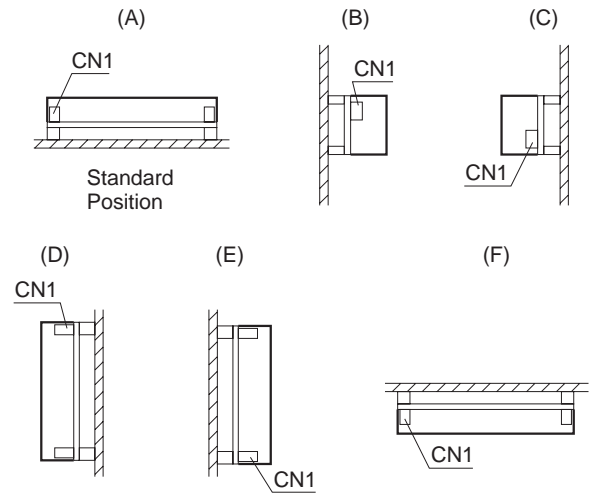

Fig.3.14 Derating curve depending on input voltage

■ Mounting method



* (F) mounting should be operated by Forced air.

Fig.3.15 Mounting method

■ The guideline for air cooling

It shows the upper temperatures of Point A and B on Table 3.1 to Table 3.6.

Please take care to keep those temperatures below the points of the tables by air convection.

And please be attentive to keep that the entire power supply is well ventilated.

At the upper temperatures of Point A and Point B (refer to External View) on Table 3.1 to Table 3.6, the expectancy life is 3 years or more.

In case of with Chassis and Cover, please contact our sales office for getting more information.

Remarks:

* Please be careful of electric shock or earth leakage in case of temperature measurement, because Point A and Point B is live potential.

* Please refer to 3.4 if you want to extend the longevity of the expectancy life.

Table 3.1 Temperatures of Point A, Point B LGA50A-3R3-Y, -5, -12, -15

Mounting Method	Cooling Method	Load factor	Max temperature	
			Point A[°C]	Point B[°C]
A	Convection	70%$I_o \leq 100\%$	85	80
		$I_o \leq 70\%$	84	80
B	Convection	20%$I_o \leq 100\%$	76	81
		$I_o \leq 20\%$	72	74
C	Convection	20%$I_o \leq 100\%$	68	68
		$I_o \leq 20\%$	65	65
D	Convection	20%$I_o \leq 100\%$	84	72
		$I_o \leq 20\%$	76	61
E	Convection	60%$I_o \leq 100\%$	66	71
		$I_o \leq 60\%$	61	70
A,B,C,D,E,F	Forced air	70%$I_o \leq 100\%$	85	80
		$I_o \leq 70\%$	80	75

Table 3.2 Temperatures of Point A, Point B LGA50A-24, -48

Mounting Method	Cooling Method	Load factor	Max temperature	
			Point A[°C]	Point B[°C]
A	Convection	60%$I_o \leq 100\%$	83	62
		$I_o \leq 60\%$	82	71
B	Convection	60%$I_o \leq 100\%$	76	62
		$I_o \leq 60\%$	82	75
C	Convection	60%$I_o \leq 100\%$	71	55
		$I_o \leq 60\%$	80	69
D	Convection	60%$I_o \leq 100\%$	82	55
		$I_o \leq 60\%$	85	69
E	Convection	60%$I_o \leq 100\%$	77	67
		$I_o \leq 60\%$	82	80
A,B,C,D,E,F	Forced air	70%$I_o \leq 100\%$	85	80
		$I_o \leq 70\%$	80	75

Table 3.3 Temperatures of Point A, Point B LGA75A-□

Mounting Method	Cooling Method	Load factor	Max temperature	
			Point A[°C]	Point B[°C]
A	Convection	70%$I_o \leq 100\%$	83	78
		$I_o \leq 70\%$	87	78
B	Convection	50%$I_o \leq 100\%$	64	66
		$I_o \leq 50\%$	74	70
C	Convection	50%$I_o \leq 100\%$	67	74
		$I_o \leq 50\%$	76	76
D	Convection	50%$I_o \leq 100\%$	81	68
		$I_o \leq 50\%$	85	73
E	Convection	40%$I_o \leq 100\%$	66	77
		$I_o \leq 40\%$	75	81
A,B,C,D,E,F	Forced air	70%$I_o \leq 100\%$	85	80
		$I_o \leq 70\%$	80	75

Table 3.4 Temperatures of Point A, Point B LGA100A-□

Mounting Method	Cooling Method	Load factor	Max temperature	
			Point A[°C]	Point B[°C]
A	Convection	70%$I_o \leq 100\%$	85	80
		$I_o \leq 70\%$	80	78
B	Convection	50%$I_o \leq 100\%$	77	74
		$I_o \leq 50\%$	75	70
C	Convection	40%$I_o \leq 100\%$	76	76
		$I_o \leq 40\%$	72	72
D	Convection	20%$I_o \leq 100\%$	84	68
		$I_o \leq 20\%$	76	65
E	Convection	40%$I_o \leq 100\%$	78	78
		$I_o \leq 40\%$	72	75
A,B,C,D,E,F	Forced air	70%$I_o \leq 100\%$	85	80
		$I_o \leq 70\%$	80	75

Table 3.5 Temperatures of Point A, Point B LGA150A-□

Mounting Method	Cooling Method	Load factor	Max temperature	
			Point A[°C]	Point B[°C]
A	Convection	60%$I_o \leq 100\%$	83	80
		$I_o \leq 60\%$	82	78
B	Convection	40%$I_o \leq 100\%$	81	74
		$I_o \leq 40\%$	77	72
C	Convection	40%$I_o \leq 100\%$	77	79
		$I_o \leq 40\%$	77	74
D	Convection	20%$I_o \leq 100\%$	85	70
		$I_o \leq 20\%$	77	65
E	Convection	20%$I_o \leq 100\%$	77	79
		$I_o \leq 20\%$	68	70
A,B,C,D,E,F	Forced air	70%$I_o \leq 100\%$	85	80
		$I_o \leq 70\%$	80	75

Table 3.6 Temperatures of Point A, Point B LGA240A-□

Mounting Method	Cooling Method	Load factor	Max temperature	
			Point A[°C]	Point B[°C]
A	Convection	35%$I_o \leq 100\%$	77	77
		$I_o \leq 35\%$	75	76
B	Convection	35%$I_o \leq 100\%$	71	74
		$I_o \leq 35\%$	71	74
C	Convection	35%$I_o \leq 100\%$	77	72
		$I_o \leq 35\%$	77	72
D	Convection	35%$I_o \leq 100\%$	82	71
		$I_o \leq 35\%$	82	71
E	Convection	35%$I_o \leq 100\%$	61	79
		$I_o \leq 35\%$	65	74
A,B,C,D,E,F	Forced air	70%$I_o \leq 100\%$	80	75
		$I_o \leq 70\%$	75	70

3.3 Mounting screw

■ The mounting screw should be M3. The hatched area shows the allowance of metal parts for mounting.

■ If metallic fittings are used on the component side of the board, ensure there is no contact with surface mounted components.

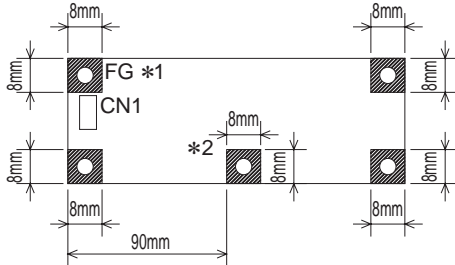

Fig.3.16 Allowance of metal parts for mounting

*1 Recommendation to electrically connect FG to metal chassis for reducing noise.

*2 LGA240A only

Refer to External view for location

3.4 Expectancy life and warranty

■ Expectancy Life.

Table 3.7 Expectancy Life (LGA50A-3R3-Y, -5, -12, -15)

Mounting Method	Cooling Method	Average ambient temperature (year)	Load factor	
			$Io \leq 75\%$	$75\% < Io \leq 100\%$
A	Convection	Ta = 40°C or less	6years	6years
		Ta = 50°C	5years	3years
B, C, D	Convection	Ta = 30°C or less	6years	6years
		Ta = 40°C	5years	3years
E	Convection	Ta = 20°C or less	6years	6years
		Ta = 30°C	5years	3years
A,B,C,D,E,F	Forced air	Ta = 60°C	5years	3years

Table 3.8 Expectancy Life (LGA50A-24, -48)

Mounting Method	Cooling Method	Average ambient temperature (year)	Load factor	
			$Io \leq 75\%$	$75\% < Io \leq 100\%$
A	Convection	Ta = 35°C or less	6years	6years
		Ta = 45°C	5years	3years
B, C, D	Convection	Ta = 30°C or less	6years	6years
		Ta = 40°C	5years	3years
E	Convection	Ta = 20°C or less	6years	6years
		Ta = 30°C	5years	3years
A,B,C,D,E,F	Forced air	Ta = 50°C	5years	3years

Table 3.9 Expectancy Life (LGA75A-□)

Mounting Method	Cooling Method	Average ambient temperature (year)	Load factor	
			$Io \leq 75\%$	$75\% < Io \leq 100\%$
A	Convection	Ta = 40°C or less	6years	6years
		Ta = 50°C	5years	3years
B, C	Convection	Ta = 30°C or less	6years	6years
		Ta = 40°C	5years	3years
D	Convection	Ta = 25°C or less	6years	6years
		Ta = 35°C	5years	3years
E	Convection	Ta = 20°C or less	6years	6years
		Ta = 30°C	5years	3years
A,B,C,D,E,F	Forced air	Ta = 60°C	5years	3years

Table 3.10 Expectancy Life (LGA100A-□)

Mounting Method	Cooling Method	Average ambient temperature (year)	Load factor	
			$Io \leq 75\%$	$75\% < Io \leq 100\%$
A	Convection	Ta = 40°C or less	6years	6years
		Ta = 50°C	5years	3years
B	Convection	Ta = 30°C or less	6years	6years
		Ta = 40°C	5years	3years
C, E	Convection	Ta = 25°C or less	6years	6years
		Ta = 35°C	5years	3years
D	Convection	Ta = 30°C or less	6years	3years
A,B,C,D,E,F	Forced air	Ta = 60°C	5years	3years

Table 3.11 Expectancy Life (LGA150A-□)

Mounting Method	Cooling Method	Average ambient temperature (year)	Load factor	
			$Io \leq 75\%$	$75\% < Io \leq 100\%$
A	Convection	Ta = 30°C or less	6years	6years
		Ta = 40°C	5years	3years
B, C	Convection	Ta = 20°C or less	6years	6years
		Ta = 30°C	5years	3years
D, E	Convection	Ta = 20°C or less	6years	3years
A,B,C,D,E,F	Forced air	Ta = 50°C	5years	3years

Table 3.12 Expectancy Life (LGA240A-□)

Mounting Method	Cooling Method	Average ambient temperature (year)	Load factor	
			$Io \leq 75\%$	$75\% < Io \leq 100\%$
A	Convection	Ta = 30°C or less	6years	6years
		Ta = 40°C	5years	3years
B, C	Convection	Ta = 20°C or less	6years	6years
		Ta = 30°C	5years	3years
D	Convection	Ta = 20°C or less	6years	3years
E	Convection	Ta = 15°C or less	6years	3years
A,B,C,D,E,F	Forced air	Ta = 50°C	5years	3years

■ Warranty

Table 3.13 Warranty (LGA50A-3R3-Y, -5, -12, -15)

Mounting Method	Cooling Method	Average ambient temperature (year)	Load factor	
			$Io \leq 75\%$	$75\% < Io \leq 100\%$
A	Convection	Ta = 40°C or less	5years	5years
		Ta = 50°C	5years	3years
B, C, D	Convection	Ta = 30°C or less	5years	5years
		Ta = 40°C	5years	3years
E	Convection	Ta = 20°C or less	5years	5years
		Ta = 30°C	5years	3years
A,B,C,D,E,F	Forced air	Ta = 60°C	5years	3years

Table 3.14 Warranty (LGA50A-24, -48)

Mounting Method	Cooling Method	Average ambient temperature (year)	Load factor	
			$Io \leq 75\%$	$75\% < Io \leq 100\%$
A	Convection	Ta = 35°C or less	5years	5years
		Ta = 45°C	5years	3years
B, C, D	Convection	Ta = 30°C or less	5years	5years
		Ta = 40°C	5years	3years
E	Convection	Ta = 20°C or less	5years	5years
		Ta = 30°C	5years	3years
A,B,C,D,E,F	Forced air	Ta = 50°C	5years	3years

Table 3.15 Warranty (LGA75A-□)

Mounting Method	Cooling Method	Average ambient temperature (year)	Load factor	
			$Io \leq 75\%$	$75\% < Io \leq 100\%$
A	Convection	Ta = 40°C or less	5years	5years
		Ta = 50°C	5years	3years
B, C	Convection	Ta = 30°C or less	5years	5years
		Ta = 40°C	5years	3years
D	Convection	Ta = 25°C or less	5years	5years
		Ta = 35°C	5years	3years
E	Convection	Ta = 20°C or less	5years	5years
		Ta = 30°C	5years	3years
A,B,C,D,E,F	Forced air	Ta = 60°C	5years	3years

Table 3.16 Warranty (LGA100A-□)

Mounting Method	Cooling Method	Average ambient temperature (year)	Load factor	
			$Io \leq 75\%$	$75\% < Io \leq 100\%$
A	Convection	Ta = 40°C or less	5years	5years
		Ta = 50°C	5years	3years
B	Convection	Ta = 30°C or less	5years	5years
		Ta = 40°C	5years	3years
C, E	Convection	Ta = 25°C or less	5years	5years
		Ta = 35°C	5years	3years
D	Convection	Ta = 30°C or less	5years	3years
A,B,C,D,E,F	Forced air	Ta = 60°C	5years	3years

Table 3.17 Warranty (LGA150A-□)

Mounting Method	Cooling Method	Average ambient temperature (year)	Load factor	
			$Io \leq 75\%$	$75\% < Io \leq 100\%$
A	Convection	Ta = 30°C or less	5years	5years
		Ta = 40°C	5years	3years
B, C	Convection	Ta = 20°C or less	5years	5years
		Ta = 30°C	5years	3years
D, E	Convection	Ta = 20°C or less	5years	3years
A,B,C,D,E,F	Forced air	Ta = 50°C	5years	3years

Table 3.18 Warranty (LGA240A-□)

Mounting Method	Cooling Method	Average ambient temperature (year)	Load factor	
			$Io \leq 75\%$	$75\% < Io \leq 100\%$
A	Convection	Ta = 30°C or less	5years	5years
		Ta = 40°C	5years	3years
B, C	Convection	Ta = 20°C or less	5years	5years
		Ta = 30°C	5years	3years
D	Convection	Ta = 20°C or less	5years	3years
E	Convection	Ta = 15°C or less	5years	3years
A,B,C,D,E,F	Forced air	Ta = 50°C	5years	3years

4 Ground

■ When installing the power supply with your unit, ensure that the input FG terminal of CN1 or mounting hole FG is connected to safety ground of the unit.

However when applying the safety agency, connect the input FG terminal of CN1 to safety ground of the unit.



Fig.4.1 Ground

5 Option and Others

5.1 Outline of options

- * Please inquire us for details of specifications and delivery timing.
- * You can combine multiple options. Some options, however, cannot be combined with other options. Please contact us for details.

● -C

- Option -C units have coated internal PCB for better moisture resistance.

● -G

- Option -G units are low leakage current type.
- Differences from standard versions are summarized in Table 5.1.

Table 5.1 Low leakage current type

		-5	-12	-24
Leakage Current (AC100/120V 60Hz)		0.1mA max		
Conducted Noise		N/A		
Output Ripple Noise [mVp-p]	0 to +50°C *1	150max	200max	200max
	-10 to 0°C *2	200max	250max	250max

*1 LGA50A-24 and LGA50A-48 are applied that the upper temperature limit is 45°C.

LGA150A and LGA240A are applied that the upper for temperature limit is 40°C.

*2 This is the value that measured on measuring board with capacitor of 22μF at 150mm from output connector. Measured by 20MHz oscilloscope or Ripple-Noise meter (Equivalent to KEISOKU-GIKEN:RM-103).

● -H (LGA50A-24,LGA75A-24,LGA100A-24,LGA150A-24,LGA240A-24)

- Option -H units can output the peak current.
- Peak load is possible to draw as below.

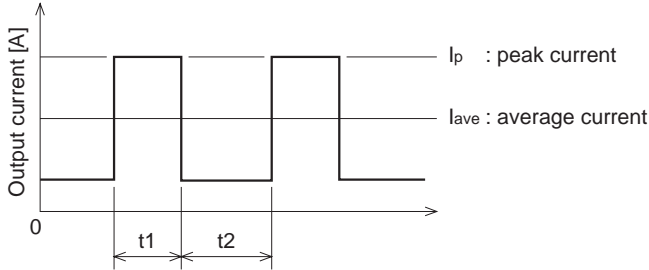

Fig.5.1 Peak current

$$t1 \leq 10 \text{ [sec]}$$

$$I_p \leq \text{rated peak current}$$

$$I_{ave} \leq \text{rated output current}$$

$$\frac{t1}{t1 + t2} \leq 0.35$$

Input voltage is AC90V to AC132V.

Remarks:

There is a possibility that an internal device is damaged when the specification is exceeded.

● -J1

- Option -J units, the Input and Output connector is VH connectors (Mfr. J.S.T.).

● -S · -SN

- -S indicates a type with chassis, and -SN indicates a type with chassis and cover (Refer to external view). Refer to “Derating Curves” in Section 3.2.

● -Y

- Option -Y units can adjust the output voltage by the potentiometer is attached .
- Refer to the adjustable range to the table 5.2.

Table 5.2 Output voltage adjustment range

	Output voltage adjustment range[V]
3.3V*	2.85 to 3.63
5V*	4.5 to 5.5
12V	10.8 to 13.2
15V	13.5 to 16.5
24V	21.6 to 26.4
48V	43.2 to 52.8

* Some of the product, -Y is standard equipment.

(LGA50A-3R3-Y, LGA75A-3R3-Y, LGA100A-3R3-Y
LGA100A-5-Y, LGA150A-3R3-Y, LGA150A-5-Y)

- To increase the output voltage, turn a built-in potentiometer clockwise.
- To decrease the output voltage, turn it counterclockwise.
- Please take care when you adjust output voltage by potentiometer, because there is possibility of electric shock and the breakdown as contacting to other internal circuit by electrically conductive tool.

5.2 Others

- This power supply is the rugged PCB type. Do not drop conductive objects in the power supply.
- At light load, there remains high voltage inside the power supply for a few minutes after power OFF.
So, at maintenance, take care about electric shock.
- This power supply is manufactured by SMD technology. The stress to PCB like twisting or bending causes the defect of the unit, so handle the unit with care.
 - Tighten all the screws in the screw hole.
 - Install it so that PCB may become parallel to the clamp face.
 - Avoid the impact such as drops.
- While turning on the electricity, and for a while after turning off, please don't touch the inside of a power supply because there are some hot parts in that.