

TAC series(50,60,80,100,150A)

TAC -50 -223

① ② ③

- ① Model Name
- ② Rated Current
- ③ Line to ground capacitor code: See table 1.1.

table 1.1 Line to ground capacitor code

Code	Leakage Current (Input 250/500V 60Hz)	Line to ground capacitor (nominal value)
103	1.0mA/2.0mA max	10,000pF
223	2.5mA/5.0mA max	22,000pF
333	3.5mA/7.0mA max	33,000pF

* When the line to ground capacitor code is different, the attenuation characteristic is different.

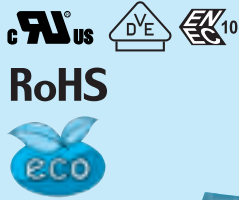

*Link to www.cosel.co.jp/en for the latest product information.

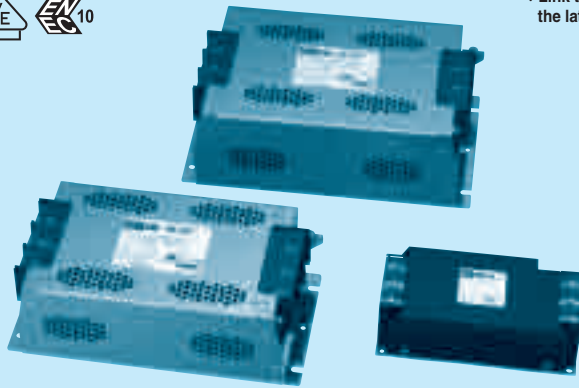

Features of TAC series

High-attenuation type of common mode noise from 150kHz to 1MHz (1-stage filter)

- Three phase rated voltage 500 VAC (voltage range:528V max)
- Selectable leakage current value

Specifications

No.	Items	TAC-50-223	TAC-60-223	TAC-80-223	TAC-100-223	TAC-150-223
1	Rated Voltage[V]	AC Three Phase 500 (voltage range:528 max)				
2	Rated Current[A]	50	60	80	100	150
3	Test Voltage (Terminal-Mounting Plate)	2,500 VAC (Cutoff Current = 100mA), 1minute at room temperature and humidity				
4	Isolation Resistance (Terminal-Mounting Plate)	500 VDC 100MΩ min at room temperature and humidity				
5	Leakage current 250/500V 60Hz	2.5mA/5.0mA max				
6	DC resistance	7mΩ max	5mΩ max	5mΩ max	4mΩ max	3mΩ max
7	Safety agency approval temperatures	-25 to +85°C (Refer to Derating Curve)				
8	Operating temperature	-40 to +85°C (Refer to Derating Curve)				
9	Operating humidity	20 to 95%RH (Non condensing)				
10	Storage temperature/humidity	-40 to +85°C/20 to 95%RH (Non condensing)				
11	Vibration	10 to 55Hz, 19.6m/s ² (2G), 3min. Period, 1hour each X, Y and Z axis				
12	Impact	196.1m/s ² (20G), 11ms Once each X, Y and Z axis				
13	Safety agency approvals	UL1283, CSA C22.2 No.8 (C-UL) , DIN EN60939 VDE0565 Teil3-1, ENEC				
14	Case size (without projection)	90 X 54 X 179 mm (W X H X D) [3.54 X 2.13 X 7.05 inches]	140 X 85 X 267 mm (W X H X D) [5.51 X 3.35 X 10.51 inches]		170 X 92 X 285 mm (W X H X D) [6.69 X 3.62 X 11.22 inches]	
15	Weight	1.4kg max	3.8kg max		4.8kg max	

Circuit Diagram

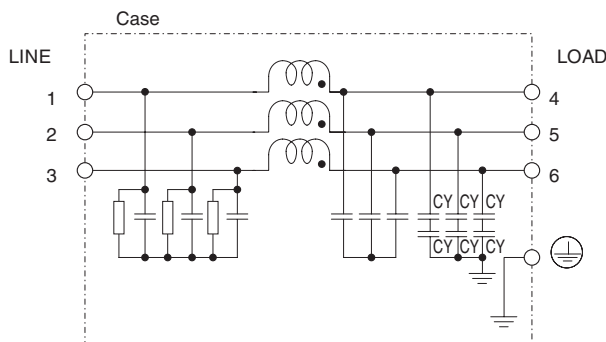

CY : Line to ground capacitor : Mounting Plate

Derating Curve

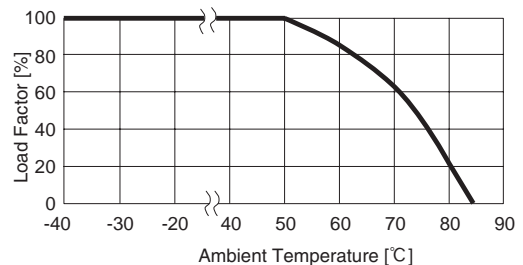

* Keep free ventilation holes for cooling.

External view

TAC-50-□□□ / TAC-60-□□□

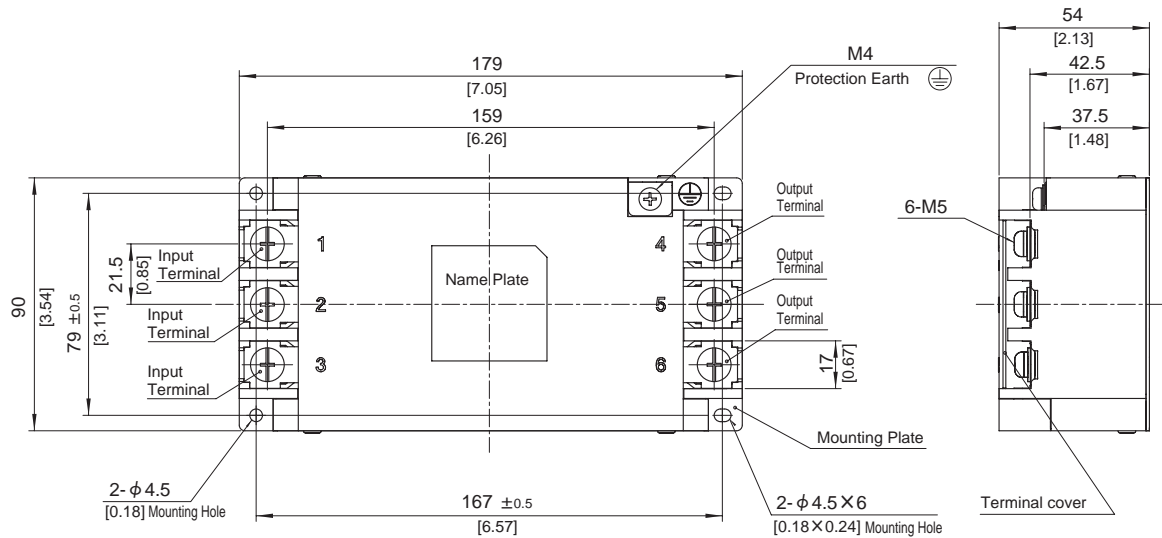

※ Can not be mounted upside-down.

※ Tolerance : ± 1 [± 0.04]

※ Weight : 1.4kg max

※ Mounting Plate : Iron (surface finishing:nickel plating) $t=1.2$ [0.05]

※ Case : PBT

※ Dimensions in mm, []=inches

※ Terminal block screw tightening torque M5:3.0N · m (30.7kgf · cm) max

※ Protection Earth screw tightening torque M4:1.6N · m (16.9kgf · cm) max

TAC-80-□□□ / TAC-100-□□□

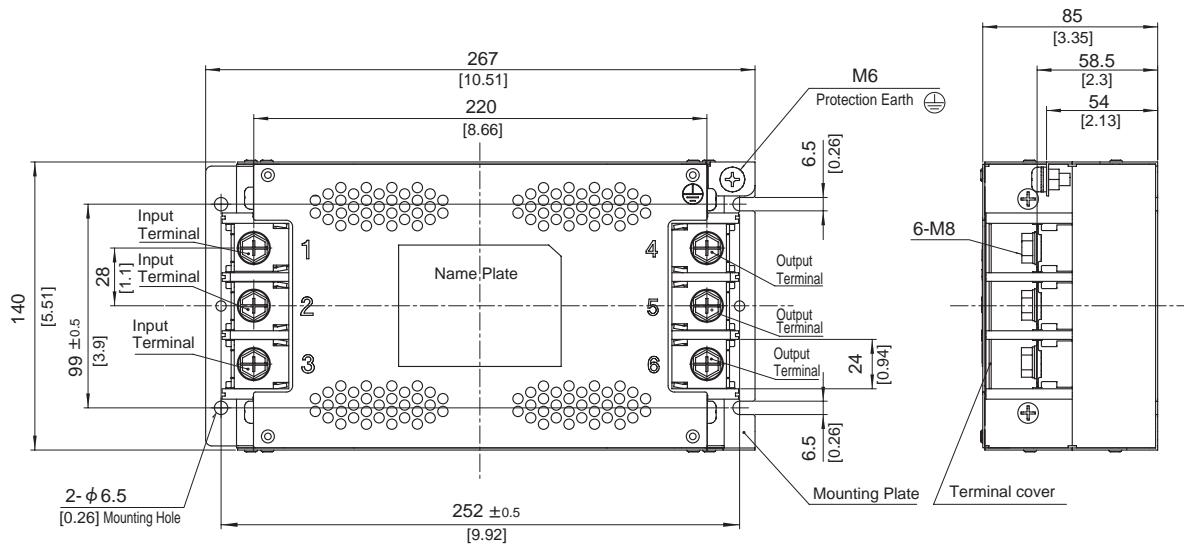

※ Can not be mounted upside-down.

※ Tolerance : ± 1 [± 0.04]

※ Weight : 3.8kg max

※ Chassis Material : Stainless steel $t=1.0$ [0.04]

※ Dimensions in mm, []=inches

※ Terminal block screw tightening torque M8:9.2N · m (93.9kgf · cm) max

※ Protection Earth screw tightening torque M6:5.8N · m (59.2kgf · cm) max

External view

TAC-150-□□□

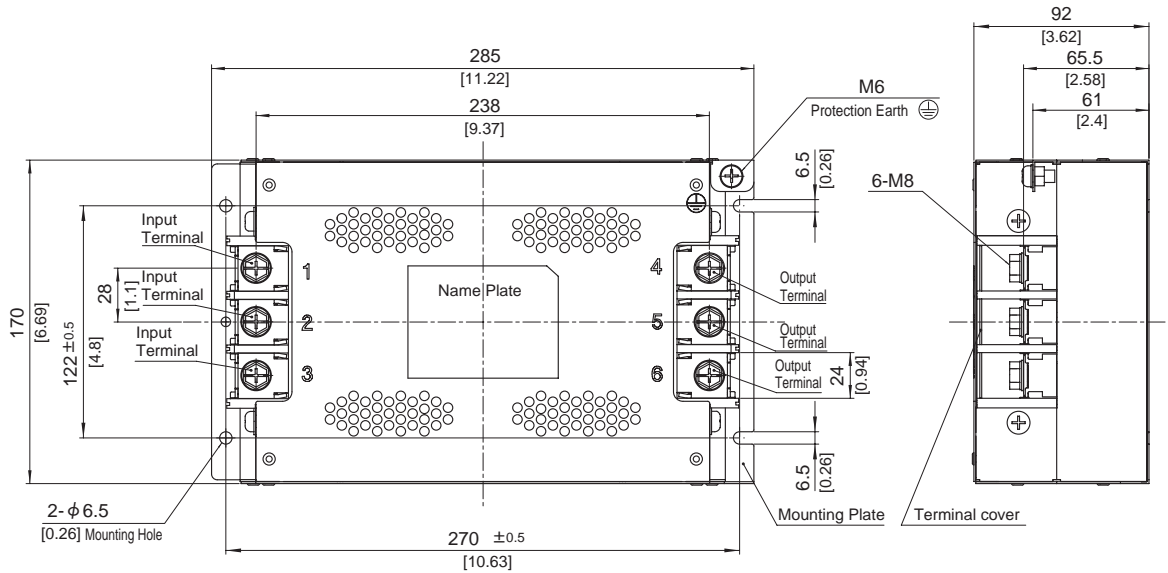

※ Can not be mounted upside-down.

※ Tolerance : ±1 [±0.04]

※ Weight : 4.8kg max

※ Chassis Material : Stainless steel t=1.0 [0.04]

※ Dimensions in mm, []=inches

※ Terminal block screw tightening torque M8:9.2N · m (93.9kgf · cm) max

※ Protection Earth screw tightening torque M6:5.8N · m (59.2kgf · cm) max